

Datum

Verantwoordelijke

Referentie



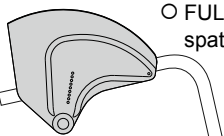

		Rolstoelmaten					
Zitbreedte (LS)	<input type="checkbox"/> 33	<input type="checkbox"/> 36	<input type="checkbox"/> 39	<input type="checkbox"/> 42	<input type="checkbox"/> 45	<input type="checkbox"/> 48	
Zitdiepte (PS)	<input type="checkbox"/> 35	<input type="checkbox"/> 37,5	<input type="checkbox"/> 40	<input type="checkbox"/> 42,5	<input type="checkbox"/> 45	<input type="checkbox"/> 47,5	<input type="checkbox"/> 50
De effectieve zitdiepte, van de voorkant van het zitzeil tot de rugbuis, zal 1,5 cm meer bedragen dan opgegeven							
Onderbeenlengte (DP)	Effectieve afstand tussen zit en voetplaat						
Waarschuwing! Van de voetplaat tot de grond minimum 4cm! Minimum hoogte voor = DP + 4 cm							
Wielpositie	☆ Standaard		<input type="checkbox"/> Voorzichtig	<input type="checkbox"/> Actief	<input type="checkbox"/> Extreem		
Rughoogte (TS)	Standaardwaarde 33,5(min 24.5-max 47)						
Camber	☆ 0° <input type="checkbox"/> 2° <input type="checkbox"/> 4°						
Hoogte voor STD 49			Hoogte achter STD 42		

	☆ Aluminium regelbare afstellingsplaat		
	☆ Afneembaar spatbord ABS	<input type="checkbox"/> rechte kledijbeschermer	
	<input type="radio"/> Afneembaar carbon spatbord		03946 254,40
	<input type="checkbox"/> rechte kledijbeschermer		

	<input type="radio"/> FULL CARBON - Regelbare afstellingsplaat met geïntegreerd spatbord		07646 795,00
	☆ Spatbord	<input type="checkbox"/> Rechte kledijbeschermer	

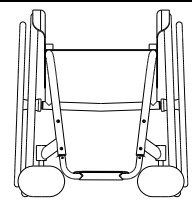
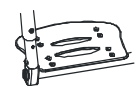
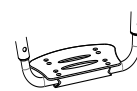
	<input type="radio"/> CARBON PACK	(Vouw-en kantelbare rolstoel)	07650 1.855,00
	FULL CARBON - Geïntegreerde spatborden - Carbon frame - Carbon achterwielen as - Lichtsste versie - Voorvork V Design		
Bespaar 370,00€ op dezelfde optionele totale meerprijs			
	☆ Spatbord	<input type="checkbox"/> Rechte kledijbeschermer	
	☆ Polished black	<input type="radio"/> Opaque black	07752 212,00

	☆ Aluminium voetplaat, hoek instelbaar			
	Minimum onderbeenlengte 35cm.			
	☆ Intern	<input type="checkbox"/> 2/3 Intern		
	<input type="checkbox"/> Extern	<input type="checkbox"/> 2/3 Extern		
			07649	84,80
<input type="radio"/> Aluminium voetplaat, met titanium buizen - hoek en diepte instelbaar				
Minimum onderbeenlengte 35cm.				
☆ Intern	<input type="checkbox"/> 2/3 Intern			
<input type="checkbox"/> Extern	<input type="checkbox"/> 2/3 Extern			
		03348	127,20	
<input type="radio"/> Eëndelige carbon voetplaat				
Minimum onderbeenlengte 35cm.				
Niet beschikbaar voor zitbreedte 48				
<input type="radio"/> Eëndelige carbon voetplaat, hoek instelbaar				
Minimum onderbeenlengte 35cm.				
☆ Intern	<input type="checkbox"/> Extern			
		03346	212,00	

	<input type="radio"/> ABS voetsteun, hoek instelbaar			
	Minimum onderbeenlengte 15cm.			
	☆ 2/3 Intern	<input type="checkbox"/> 2/3 Extern		
			06814	159,00
	<input type="radio"/> Eëndelige aluminium voetplaat - flip-up, hoek en diepte instelbaar			
Minimum onderbeenlengte 15cm.				
<input type="checkbox"/> Intern	<input type="checkbox"/> 2/3 Intern			
<input type="checkbox"/> Extern	<input type="checkbox"/> 2/3 Extern			
		06856	159,00	
<input type="radio"/> Eëndelige carbon voetplaat hoek instelbaar, wegzwenkbaar, flip-up				
Minimum onderbeenlengte 15cm.				
☆ Intern	<input type="checkbox"/> Extern			
		06857	339,20	

Rehateam s.r.l. Vicoio Negrelli, 4 - 31040 Castagnole di Paese (TV) - Tel. +39.0422.484657 / +39.0422.480387 - Fax +39.0422.484661 / +39.0422.484684
 P.IVA IT 03182520266 - C.C.I.A.A. TV n.41690 Capitale Sociale I.V. Euro 100.000,00

E-mail: info@rehateamprogeo.com - web: http://www.rehateamprogeo.com

Datum

Verantwoordelijke

Referentie

Voorframe

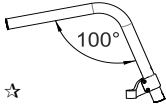
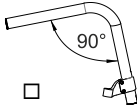
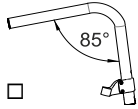
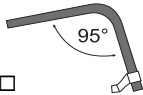
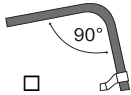
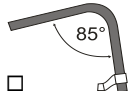
Aluminium frame	☆ Aluminium standaard frame				Kleur aluminium frame ☆ Bright zilver <input type="checkbox"/> Polished zwart <input type="checkbox"/> Opaque zwart <input type="checkbox"/> Bright blauw <input type="checkbox"/> Bright antraciet <input type="checkbox"/> Bright oranje <input type="checkbox"/> Bright fuchsia <input type="checkbox"/> Bright rood <input type="checkbox"/> Bright limoen <input type="checkbox"/> Bright china blauw <input type="checkbox"/> Pearl wit	
	☆			max 4" voorwiel		
Carbon frame	○ Carbon frame Standaard in carbon pack					03347 1.272,00
	○			max 4" voorwiel		

As achterwielen

☆ Aluminium as		
○ Carbon as Standaard in carbon pack	07647	127,20

Rugleuning - hoek verstelbaar van -4° tot +16°

☆ Rugleuning met dubbele vergrendeling	<input type="checkbox"/> Rugleuning met enkele vergrendeling (niet neergeklapt)	
☆ Aluminium rugleuning		
○ Titanium rugleuning		
○ Carbon rugleuning		
○ AIR - houding rugleuning - lateraal behoud standaard 6,5cm. Niet beschikbaar voor zitbreedte 48 - standaard rugbekleding niet voorzien - Handvaten aluminium met korte buizen		06811 106,00 04389 583,00 06815 985,80

Carbon schaal H25 - Hoogte	<input type="checkbox"/> 29	<input type="checkbox"/> 30,5	<input type="checkbox"/> 32	<input type="checkbox"/> 33,5	<input type="checkbox"/> 35	<input type="checkbox"/> 36,5
Carbon schaal H33 - Hoogte	<input type="checkbox"/> 37	<input type="checkbox"/> 38,5	<input type="checkbox"/> 40	<input type="checkbox"/> 41,5	<input type="checkbox"/> 43	<input type="checkbox"/> 44,5

AIR hoes STANDAARD
Kleur : Zilver

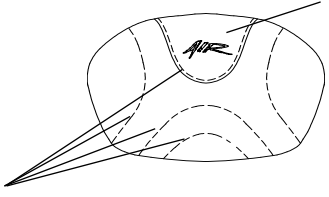

Ademende stof en stiksels
Kleur : Grijs

AIR hoes SPORT
Kleur : Zwart

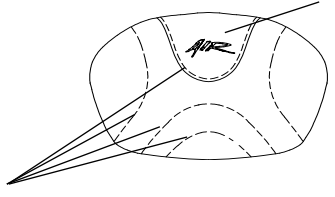

Ademende stof en stiksels
Kleur :
 Zilver Limoen Oranje Rood
 Fuchsia Blauw Antraciet Zwart

AIR hoes ACTIVE
Kleur :
 Rood
 Limoen
 Blauw

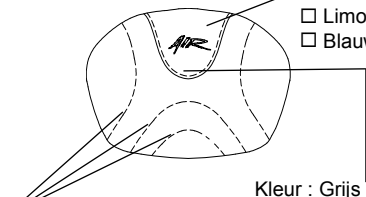

Ademende stof en stiksels
Kleur : Zwart

Handvaten

☆ Handvaten STD		
<input type="checkbox"/> Handvaten met korte buizen		
<input type="checkbox"/> Handvaten SPORT zonder duwhandvaten		
○ carbon fiber handvaten (met korte buizen) niet beschikbaar met: houding rugleuning PHYSIO - houding rugleuning A I R	(Vouw-en kantelbare rolstoel)	04390 106,00
○ Vouwbare handvaten aluminium		02958 212,00

Rehateam s.r.l. Vicolo Negrelli, 4 - 31040 Castagnole di Paese (TV) - Tel. +39.0422.484657 / +39.0422.480387 - Fax +39.0422.484661 / +39.0422.484684
 P.IVA IT 03182520266 - C.C.I.A.A. TV n.225667 - Iscr.Trib. TV n.41690 Capitale Sociale I.V. Euro 100.000,00

Email: info@rehateamprogeo.com - web: http://www.rehateamprogeo.com

Nederlands

Datum Verantwoordelijke Referentie

Voorwielen

- ☆ 4" Soft
 - 3" Sport
 - 5" Soft
 - 6" Soft
 - 6" Lucht
 - 3" Actief Soft (large)
 - 4" Actief Sport (small)
 - 4" Actief Soft (large)
 - 5" Actief Soft (large)
- | | | | | | |
|---------------------------------|-------|--|--|--|---------------|
| Enkel met 100° framehoek | | | | | |
| Enkel met 100° framehoek | | | | | |
| Aluminium velg | 06824 | | | | 117,30 |
| Aluminium velg | 01398 | | | | 117,30 |
| Aluminium velg | 03943 | | | | 117,30 |
| Aluminium velg | 07518 | | | | 117,30 |

Voorvork

- ☆ Voorvork V Design
 - Lichtste versie
 - Voorvork met geïntegreerde waterpas
- Niet mogelijk i.c.m 6" voorwielen- JOKER ZERO
Standaard in Carbon pack**
- 
- | | | | | | |
|--|-------|--|--|--|--------------|
| | | | | | |
| | 07648 | | | | 53,00 |

Optioneel

- Voorvork met vering FROG LEGS
- Kleur: zwart
Enkel met voorwielen 3" 4" 5"**
- 
- | | | | | | |
|--|-------|--|--|--|---------------|
| | | | | | |
| | 06426 | | | | 424,00 |

Kleurenset: achterwielen en vorken - enkel te matchen met achterwielen Ultra-light Progeo - standaard (22 - 24)

- ☆ Polished black
 - Bright silver
 - Bright antracite
 - Bright orange
 - Bright fuchsia
 - Bright blue
 - Bright red
 - Bright lime
 - Pearl white
- | | | | | | |
|-----------------|--|--|--|-------|---------------|
| 22" 24" 25" 26" | | | | | |
| 22" 24" | | | | 00833 | 125,80 |
| 24" | | | | 00833 | 125,80 |
| 22" 24" | | | | 00833 | 125,80 |
| 22" 24" | | | | 00833 | 125,80 |
| 22" 24" | | | | 00833 | 125,80 |
| 22" 24" | | | | 00833 | 125,80 |
| 22" 24" | | | | 00833 | 125,80 |
| 24" | | | | 00833 | 125,80 |

Achterwielen

- ☆ 24" Ultra-light Progeo - standaard!
 - 22" Ultra-light Progeo - standaard
 - 25" Ultra-light Progeo - standaard
 - 26" Progeo - standaard
 - 24" Ultra-light Progeo Key Sport
 - 24" Ultra-light "Spinergy LX"
 - 24" Ultra-light "Spinergy Flex rim"
 - 24" Ultra-light "Spinergy LXL"
 - 25" Ultra-light "Spinergy LX"
 - 25" Ultra-light "Spinergy LXL"
 - 26" Ultra-light "Spinergy LX"
 - 24" Off-road
- | | | | | | |
|--|-------|--|--|--|-----------------|
| | | | | | |
| | 04383 | | | | 720,80 |
| | 01685 | | | | 720,80 |
| | 02270 | | | | 1.166,00 |
| <input type="checkbox"/> Zwarte naaf en spaken | 07846 | | <input type="checkbox"/> Zwarte naaf en witte spaken | | 720,80 |
| | 02101 | | | | 720,80 |
| <input type="checkbox"/> Zwarte naaf en spaken | 07847 | | <input type="checkbox"/> Zwarte naaf en witte spaken | | 720,80 |
| | 02102 | | | | 720,80 |
| | 01392 | | | | 159,00 |

Achterbanden

- ☆ Hogedruk band (22"-24"-25"-26")
 - Hogedruk profielband (24")
 - Marathon plus (24"-25")
 - Kik tyre Mako - kleur zwart (24")
 - Kik tyre Mako - kleur grijs (24")
- Met anti-leklaag bescherming**
- | | | | | | |
|--|-------|--|--|--|--------------|
| | | | | | |
| | 01669 | | | | 73,00 |
| | 01041 | | | | 84,80 |
| | 01751 | | | | 84,80 |













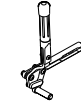















Hoepel - wielafstand

- ☆ Aluminium (22"-24"-25"-26")
 - Verchroomd staal (24"-25")
 - Titanium (24"-25")
 - Ultra grip (24"-25")
 - Max grip (24"-25")
 - Ergo para (24")
 - Surge LT (24"-25")
 - Quad (24") (24")
 - silicone cover voor standaard aluminium hoepel
- ☆ 3 cm □ 4 cm**
- Niet beschikbaar met Spinergy**
- Ovaal profiel met rubberen inzetstuk**
- Beschikbaar voor maten (22"-24"-25"-26")**
- | | | | | | |
|--|-------|--|--|--|---------------|
| | | | | | |
| | 01684 | | | | 106,00 |
| | 00016 | | | | 212,00 |
| | 00017 | | | | 254,40 |
| | 00834 | | | | 296,80 |
| | 00632 | | | | 296,80 |
| | 06427 | | | | 307,40 |
| | 00693 | | | | 185,18 |
| | 04050 | | | | 185,18 |

Rehateam s.r.l. - Vicolo Negrilli, 4 - 31040 Castagnole di Paese (TV) - Tel. +39.0422.484657 / +39.0422.480387 - Fax +39.0422.484661 / +39.0422.484684
 P.IVA IT 03182520266 - C.C.I.A.A. TV n.225667 - Iscr.Trib. TV n.41690 Capitale Sociale I.V. Euro 100.000,00

Email: info@rehateamprogeo.com - web: http://www.rehateamprogeo.com

Nederlands

Datum	Verantwoordelijke		Referentie	
Remmen				
<input checked="" type="checkbox"/> Gebogen duwremmen 				
<input type="checkbox"/> Rechte duwremmen 				
<input type="checkbox"/> Rechte trekremmen 				
<input type="checkbox"/> Sportremmen OUT-FRONT 				
<input type="checkbox"/> Verlengde duwremmen 				
<input type="checkbox"/> Verlengde trekremmen 				
Armsteunen				
<input type="checkbox"/> Wegzwenkbare armsteunen 				
Afneembaar en in hoogte verstelbaar				
<input checked="" type="checkbox"/> Pad STANDAARD 				
<input type="checkbox"/> Ergonomisch pad (30x6 cm) 				
Optioneel				
<input type="checkbox"/> Transitwielen 				
Niet mogelijk i.c.m. anti-tip				
<input type="checkbox"/> Anti-tip STANDAARD 				
Niet mogelijk i.c.m. transitwielen				
<input type="checkbox"/> Rechts 				
<input type="checkbox"/> Links 				
<input type="checkbox"/> Anti-tip met quick release 				
Interne rotatie - plaatsbesparend				
<input type="checkbox"/> Rechts 				
<input type="checkbox"/> Links 				
<input type="checkbox"/> Duwhandvaten voor begeleider 				
Afneembaar en in hoogte verstelbaar				
<input type="checkbox"/> Tetraclip 				
Quick release assen voor quadriplegie				
<input type="checkbox"/> Framebeschermers (per paar) 				
<input type="checkbox"/> Veiligheidsgordel 				
<input type="checkbox"/> Lumbale steun 				
Extra vulling in de rugbekleding				
<input type="checkbox"/> Wegzwenkbare laterale steun 				
Niet beschikbaar voor: rugleuning PHYSIO - rugleuning A I R				
<input type="checkbox"/> Rechts 				
<input type="checkbox"/> Links 				
<input type="checkbox"/> Spaakbeschermers zwart (22"-24") 				
<input type="checkbox"/> Spaakbeschermers transparant (22"-24") 				
<input type="checkbox"/> Spaakbeschermers Progeo design (22"-24") 				
<input type="checkbox"/> Spaakbeschermers draak (22"-24") 				
Extra kit				
<input type="checkbox"/> 24" Off-road achterwielen 				
Enkel met aluminium hoepel				

Rehateam s.r.l. Vicolo Negrilli, 4 - 31040 Castagnole di Paese (TV) - Tel. +39.0422.484657 / +39.0422.480387 - Fax +39.0422.484661 / +39.0422.484684
 P.IVA IT 03182520266 - C.C.I.A.A. TV n.225867 - Iscr. Trib. TV n.41690 Capitale Sociale I.V. Euro 100.000,00

Email: info@rehateamprogeo.com - web: http://www.rehateamprogeo.com

Nederlands

Datum

Verantwoordelijke

Referentie

PHYSIO-rugleuning - Standaard rugbekleding wordt niet voorzien

Aluminium schaal - laterale steun STANDAARD: 7,5cm



Hoogte 25 33 41
Hoogte 52

05308 **858,60**
05309 **911,60**

A = hoog B = laag

Aluminium schaal - laterale steun DIEP: 15cm



Hoogte 25 33 41
H25 niet beschikbaar voor zitbreedte 39-42-45-48

05310 **911,60**
05311 **964,60**

Hoogte 52

05311 **964,60**

A = hoog B = laag

Carbon schaal - laterale steun STANDAARD: 7,5cm



Hoogte 25 33 41

05312 **985,80**

A = hoog B = laag

HOES

☆ Cover Plus voorzien van tasje met ritsluiting voor persoonlijke bezittingen, voorzien van reflecterende naden



Wegzwenkbare - laterale ondersteuning

- Large (17,5x11,5)
- Small (14x9,5)

Rechts **05646**
 Rechts **05642**

Links **05647**
 Links **05643**



169,60
169,60

Niet mogelijk i.c.m. Physio Deep en carbon rug
Niet beschikbaar i.c.m. rugleuning A I R

Aanpasbare hoofdsteun - dubbele-bal-montageset
Niet mogelijk voor rughoogte 25 en carbon schaal



large (34x14)
 smal (28x14)

05648 **381,60**

opties MBO

Softrol 4" voorwielen

86,92

Softrol 5" voorwielen

86,92

Standaard zitkussen met airhoes



Breedte:

Diepte:

117,50

Bijlage bestelbon

Referentietabellen

1	Hoogte voor			
	Met gesloten frame (95°) max 5" voorwiel Met gesloten frame (90°) max 5" voorwiel Met gesloten frame (85°) max 4" voorwiel			
	voorwielen			
VORK	3"	4"	5"	6"
SPORT 	max 52	max 53	max 54	
Small 	max 54	max 55	max 56	max 57
Medium 	max 56	max 57	max 58	max 59

De grootte van de vork wordt enkel bepaald door Rehateam Progeo in overeenstemming met de finale configuratie van de rolstoel

2	Achterwielen			
	22"	24"	25"	26"
min	36	38	39	40
max	44	46	47	48

3	optie voetplaat	voetplaatafstand
	Aluminium voetplaat - in hoek verstelbaar	min 35
	Eéndelige carbon voetplaat	min 35
	Eéndelige carbon voetplaat - in hoek verstelbaar	min 35
	ABS voetsteun, in hoek verstelbaar	min 35
	Eéndelige aluminium voetplaat - flip-up, hoek en diepte instelbaar	min 35
	Eéndelige carbon voetplaat - flip up, hoek instelbaar, wegzwenkbaar	min 35
Waarschuwing! Van de voetplaat tot de grond minimum 4cm! Minimum hoogte voor = DP + 4 cm		
Berekend in de beste configuratie met voetplaat "intern"		
Lagere voetplaatafstanden zijn enkel mogelijk goedkeuring van Progeo		

4	Achterwielen	
	Model	Kenmerken
	22" Ultra-light Progeo - standaard	Niet beschikbaar in antraciet kleur
	24" Ultra-light Progeo - standaard	Beschikbaar voor alle kleuren
	24" Ultra-light Progeo Key Sport	Zilveren naaf, zwarte velg en 16 spaken
	24" Ultra-light "Spinergy LX"	Zilveren naaf, zwarte velg en spaken
	24" Ultra-light "Spinergy LXL"	Zwarte naaf en velg, 18 witte spaken - Zwarte naaf en velg, 18 zwarte spaken
	24" Ultra-light "Spinergy Flex rim"	Zilveren naaf, zwarte velg en spaken, geïntegreerde aluminium/rubber hoepel, alle types banden
	24" Off-road	Kleur: zwart, aluminium hoepel, off-road band
	25" Ultra-light "Spinergy LX"	Zilveren naaf, zwarte velg en spaken
	25" Ultra-light "Spinergy LXL"	Zwarte naaf en velg, 18 witte spaken - Zwarte naaf en velg, 18 zwarte spaken
	26" Progeo - standaard	Kleur: zwart
	26" Ultra-light "Spinergy LX"	Zilveren naaf, zwarte velg en 18 zwarte spaken